

bios

Luna Series

Fixture Assembly + Materials

What's In The Box:

The following items and quantities should arrive with your purchase of the Luna LED grow light. If you are missing items in your fixture box, please contact help@bioslighting.com

(2) Standard Mounting Brackets
SKU: BP-000B-000-LUNA01-1

(2) Long Mounting Brackets*
SKU: BP-000B-000-LUNA02-1

(1) BIOS PSU
(Power Supply Unit)

(1) Luna Fixture

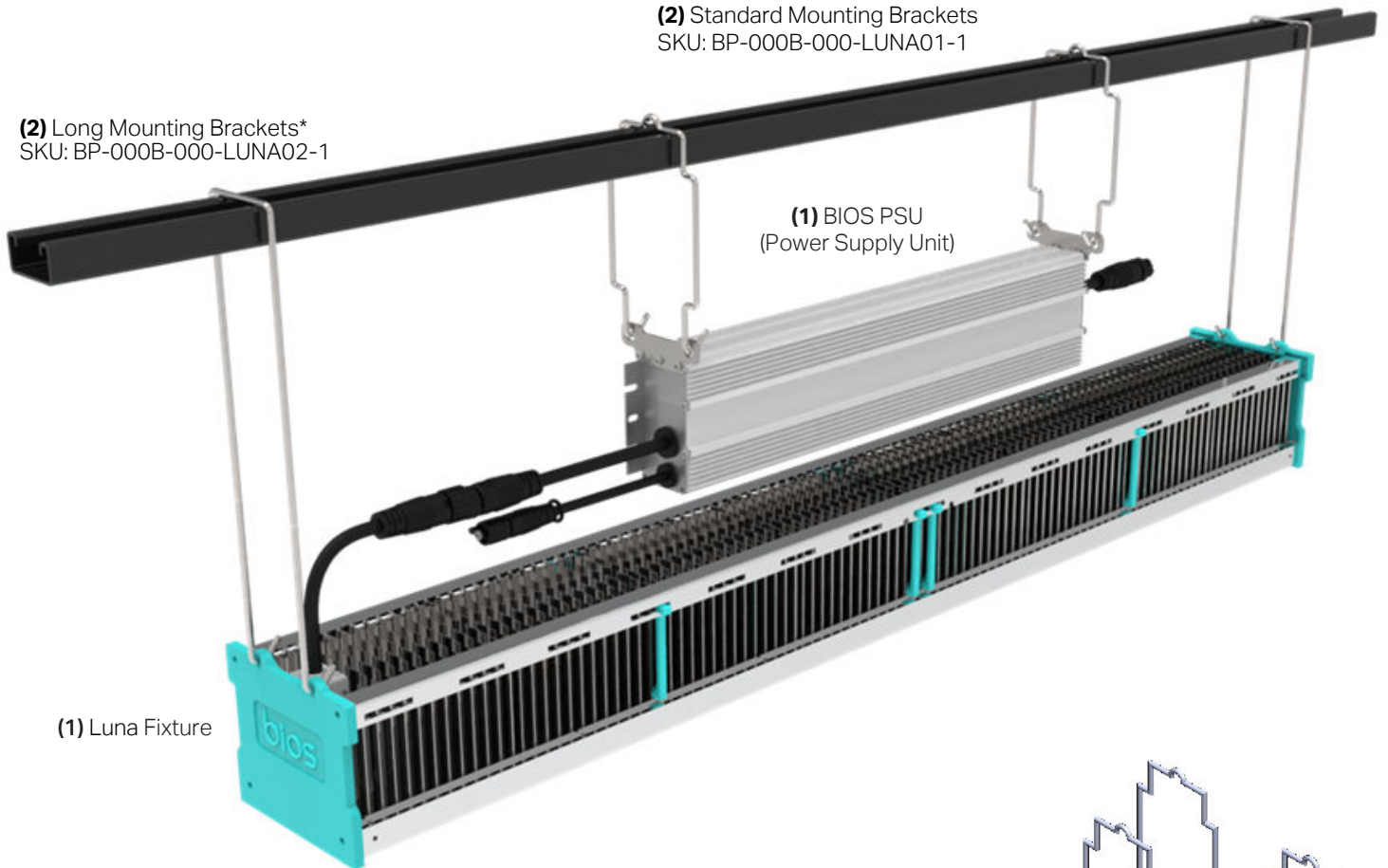

* Long Mounting Brackets only
included with Luna 1750

Luna 2015 includes (4) Standard
Mounting Brackets (2 pairs)

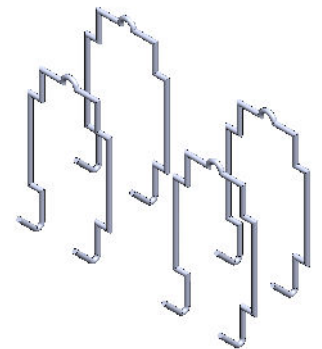

bios

Luna Series

Light Fixture Assembly

The following diagrams provide step-by-step instruction to assemble your Luna fixture and PSU. Best practice is to assemble the unit on a flat surface.

Step 1:

Align the **DC Cable input** on your **BIOS Power Supply (PSU)** with the **DC Cable** attached to your **Luna** fixture. (align the connection points circled below).

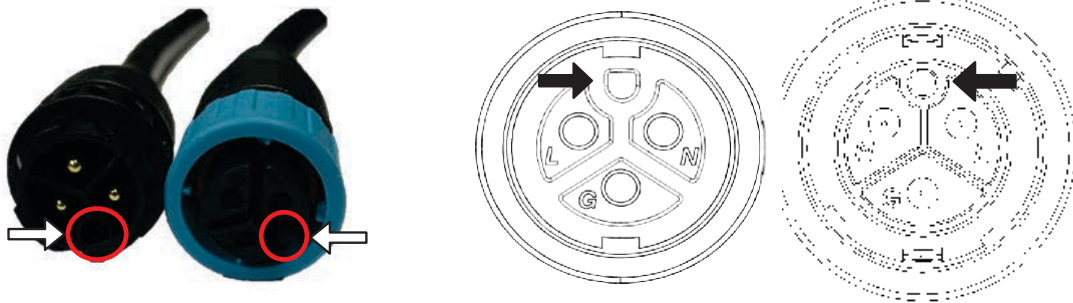

Step 2:

Connect the fixture cable to the **DC Cable** input. Reference the arrows on each side on the side of each cable to ensure the cables are aligned.

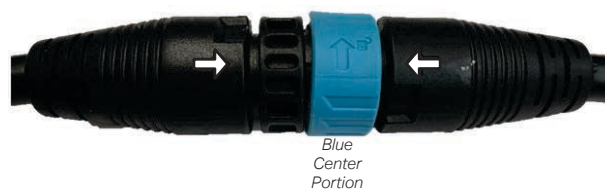

Note: The blue center portion must be turned to disconnect the cables.

Luna Series

Unistrut Mounting Instructions - Channel-Side Up (Method 1)

The following outlines the steps for mounting the fixtures to a Unistrut Channel, where the channel is mounted with open channel-side facing up.

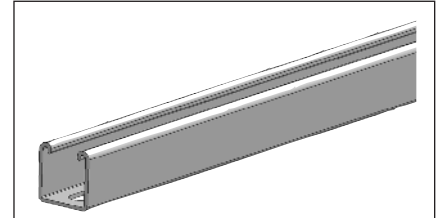

Unistrut Channel-Side Up

Recommended Hardware

Note: Hardware included

(2) Standard Mounting Brackets
SKU: BP-000B-000-LUNA01-1

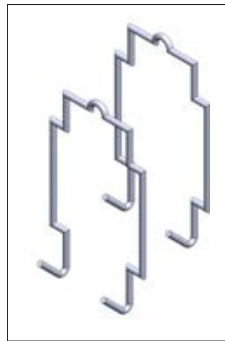

Installation Notes

Step 1:

Hang two (2) **Standard Mounting Brackets** on the unistrut channel, approx. 17in apart (length of power supply).

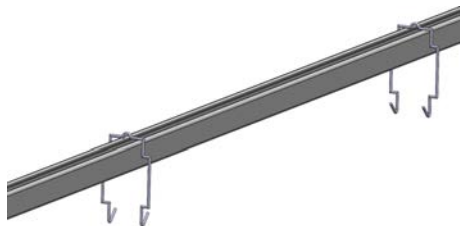

Step 2:

Hook the Standard Mounting Bracket ends into the hanger holes on the light fixture.

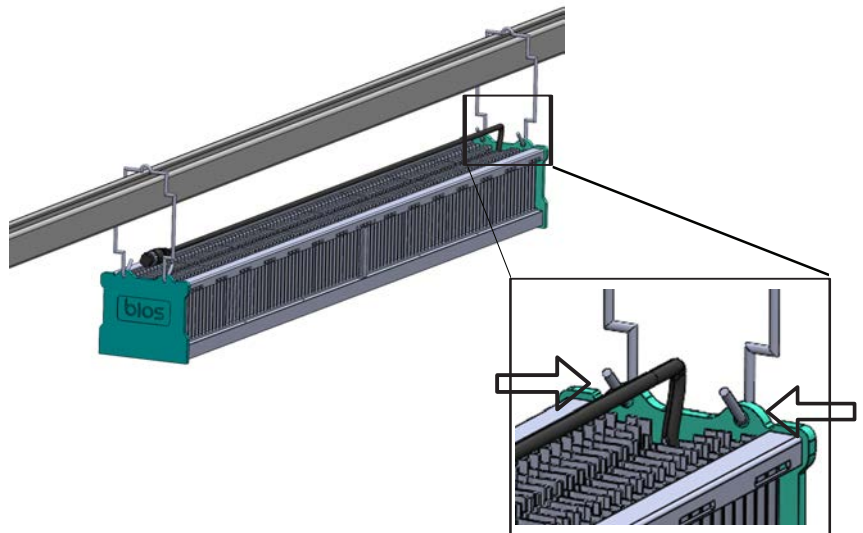

Luna Series

Unistrut Mounting Instructions - Channel-Side Down (Method 1)

The following outlines the steps for mounting the fixtures to a Unistrut Channel, where the channel is mounted with open channel-side facing up.

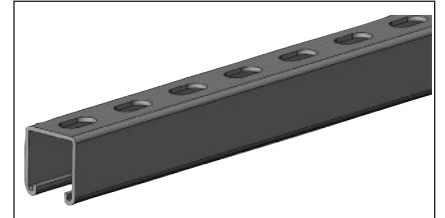

Unistrut Channel-Side Down

Recommended Hardware

Note: Hardware included

(2) Standard Mounting Brackets
SKU: BP-000B-000-LUNA01-1

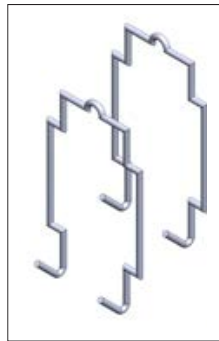

Installation Notes

Step 1:

Hang two (2) **Standard Mounting Brackets** on the unistrut channel, approx. 17in apart (length of power supply).



Step 2:

Hook the Standard Mounting Bracket ends into the hanger holes on the light fixture.

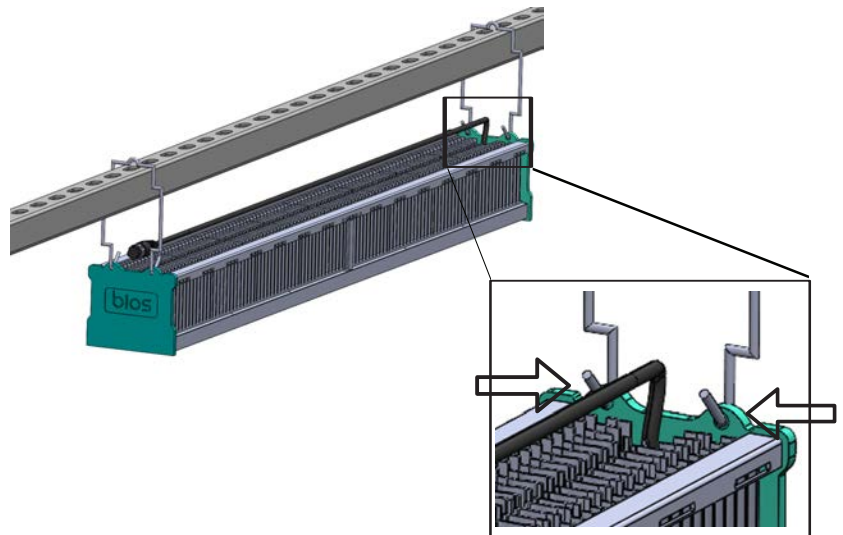

Unistrut Mounting Instructions - Channel-Side Up or Down

The following outlines the steps for mounting the fixtures and PSUs to a Unistrut Channel, where the channel is mounted with open channel-side facing up OR down.

Recommended Hardware

Note: Hardware included

(2) Long Mounting Brackets*
SKU: BP-000B-000-LUNA02-1



(2) Standard Mounting Brackets
SKU: BP-000B-000-LUNA01-1

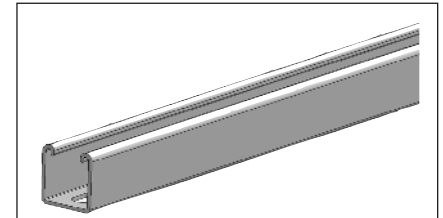

Unistrut Channel-Side Up

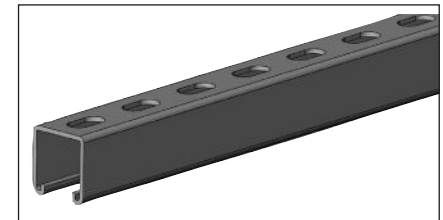

Unistrut Channel-Side Down

Installation Notes

Fixture and PSU should be disconnected before proceeding!

Step 1:

Hang two (2) Standard Mounting Brackets on the unistrut channel, approx. 17in apart (length of power supply).

Step 2:

Hook the bracket ends into the hanger holes on the power supply.

Step 3:

Hang two (2) Long Mounting Brackets on the unistrut channel, approx. 38in apart (length of fixture), with Standard Mounting Brackets and power supply centered between Long Mounting Brackets.

Step 4:

Hook the bracket ends into the hanger holes on the fixture.
Connect PSU to fixture after hanging both.

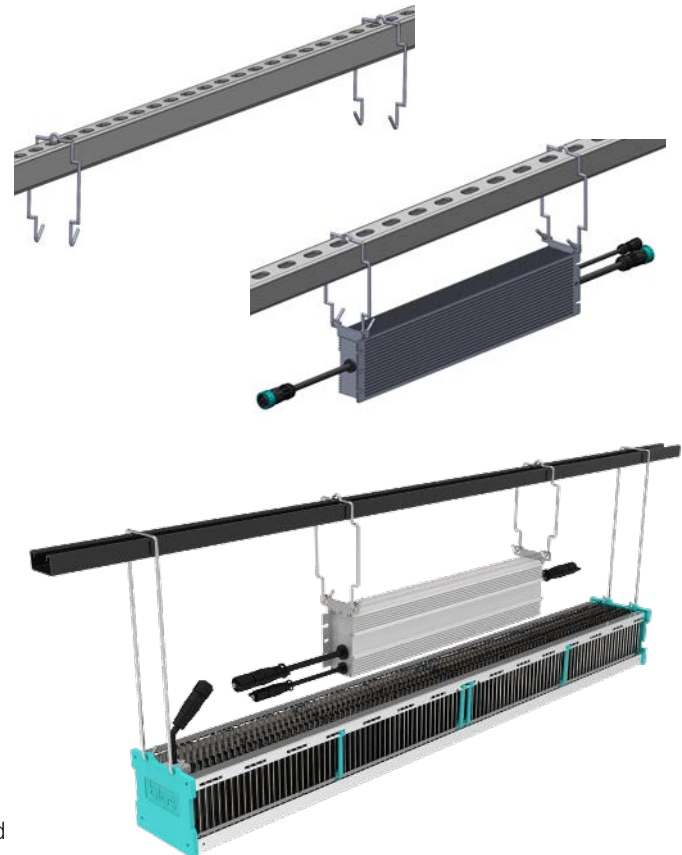

* Long Mounting Brackets only included with Luna 1750

Luna 2015 includes (4) Standard Mounting Brackets (2 pairs)

Luna Series

Unistrut Mounting Instructions - Channel-Side Up (Method 3)

The following outlines the steps for mounting the fixtures to a Unistrut Channel, where the channel is mounted with open channel-side facing up.

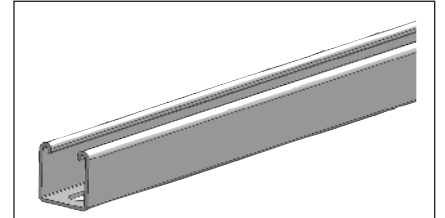

Unistrut Channel-Side Up

Recommended Hardware

Note: Hardware not included, must be ordered separately

*Perpendicular Mounting Bracket
SKU: BP-000B-000-LUNA03-1*



Installation Notes

Step 1:

Hang two (2) *Perpendicular Mounting Brackets* on the unistrut channel.

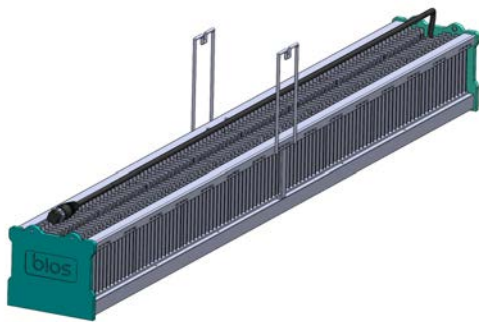

Step 2:

Hook the perpendicular Mounting Bracket ends into the hanger slots on the light fixture.

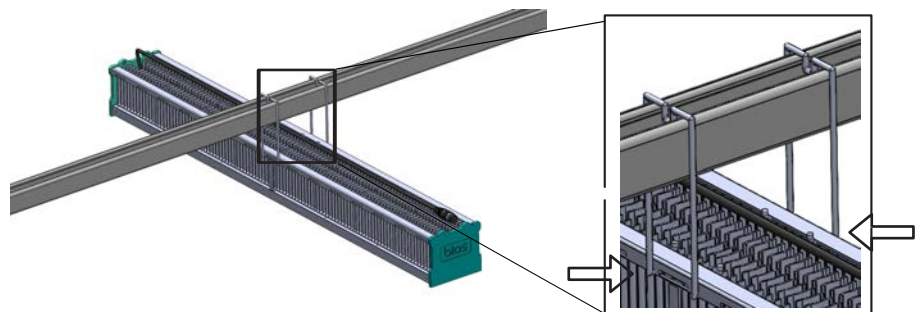

Unistrut Mounting Instructions - Channel-Side Up (Method 2)

The following outlines the steps for mounting the fixtures to a Unistrut Channel, where the channel is mounted with open channel-side facing up.

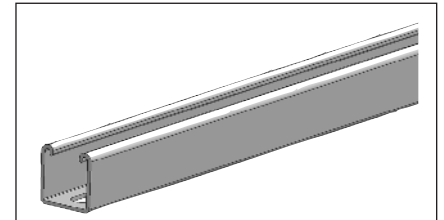

Unistrut Channel-Side Up

Recommended Hardware

Note: Hardware not included

Eye Bolt

Washer

Nut



Small Y-Cable with Carabiners
SKU: BP-000B-000-YKAB02-1

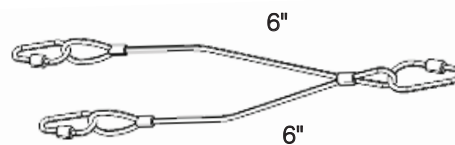

Note: Hardware not included, must be ordered separately

Installation Notes

Step 1:

Thread the *nut* and *washer* onto the *eye bolt*.

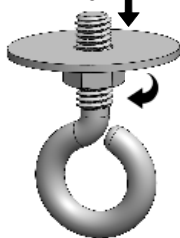

Step 2:

Place the *eye bolt assembly* from Step 1 through the unistrut slot. Then thread another *washer* and *nut* on top of the assembly and tighten.

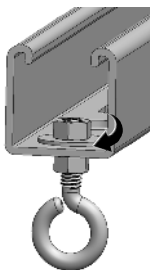

Step 3:

Repeat *Steps 1-3*, locate the mounting hardware along the channel so the hardware spacing aligns with the nominal fixture length.

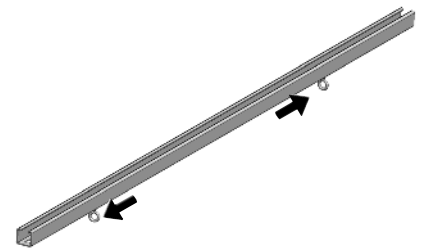

For example: Mounting hardware for a 3ft fixture should be spaced approximately 3ft apart (or less) so that the cable assembly can be suspended from the mounting hardware locations.

Step 4:

Clip the carabiner on the single end of the looped y-cable to the eye bolts. Clip the other suspended carabiners into the hanger holes on the light fixture.

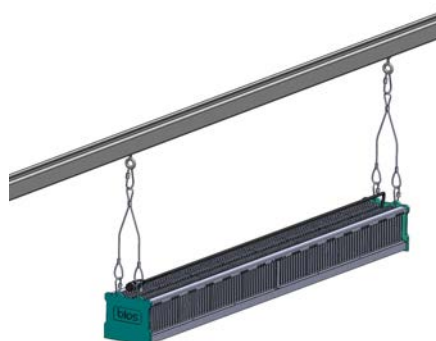

Unistrut Mounting Instructions - Channel-Side Down (Method 2)

The following outlines the steps for mounting the fixtures to a Unistrut Channel, where the channel is mounted with open channel-side facing down.

Recommended Hardware

Note: Hardware not included

Strut Channel Nut with Spring

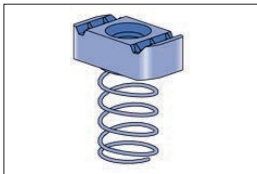

Eye Bolt



Washer



Nut



Note: Hardware not included, must be ordered separately

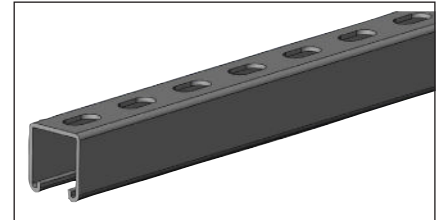

Unistrut Channel-Side Down

Small Y-Cable with Carabiners
SKU: BP-000B-000-YKAB02-1

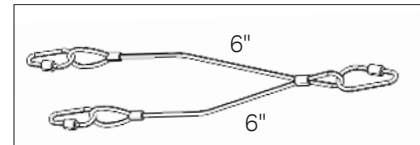

Installation Notes

Step 1:

Place the **Strut Channel Nut with Spring** in the Unistrut Channel.

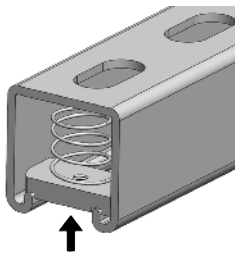

Step 2:

Thread the **nut** and **washer** onto the eye bolt.

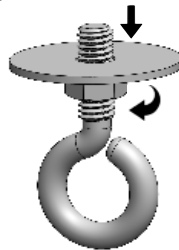

Step 3:

Thread **assembly** from Step 2 into the **Strut Channel Nut** from Step 1.

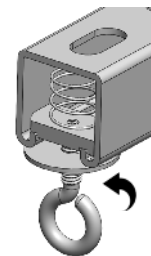

Step 4:

Repeat **Steps 1-3**, locate the mounting hardware along the channel so the hardware spacing aligns with the nominal fixture length.

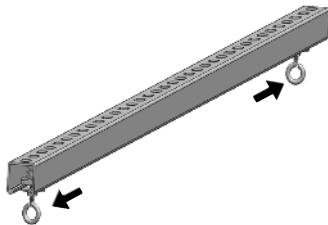

For example: Mounting hardware for a 3ft fixture should be spaced approximately 3ft apart (or less) so that the cable gripper assembly can be suspended from the mounting hardware locations.

Step 5:

Clip the carabiner on the single end of the looped y-cable to the eye bolts. Clip the other suspended carabiners into the hanger holes on the light fixture.

Repeat Steps 1-5 for all fixtures along the length of the Unistrut.

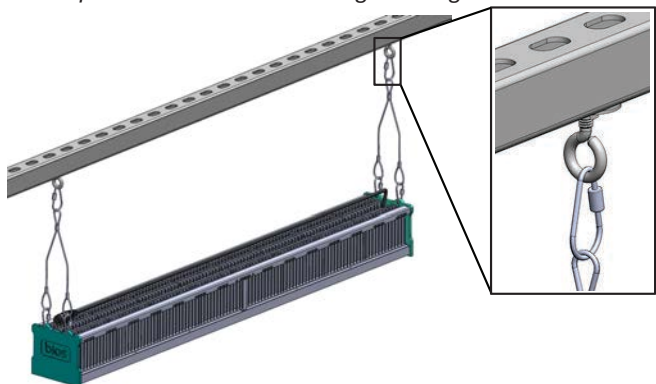

Unistrut Mounting Instructions - Channel-Side Up or Down

The following outlines the steps for mounting the fixtures to a Unistrut Channel, where the channel is mounted with open channel-side facing up OR down.

Recommended Hardware

Note: Hardware not included

Looped Cable



Carabiner

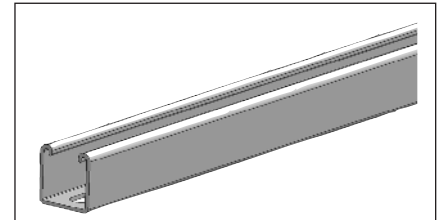

Unistrut Channel-Side Up

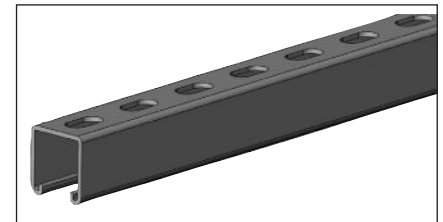

Unistrut Channel-Side Down

Note: Hardware Included

(2) Standard Mounting Brackets
SKU: BP-000B-000-LUNA01-1

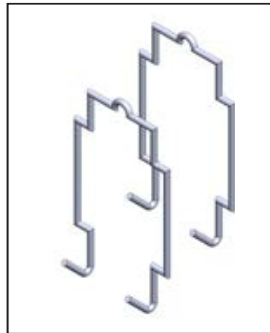

Installation Notes

Step 1:

Connect the *carabiner* to one of the *loops* on the end of the *looped cable*.

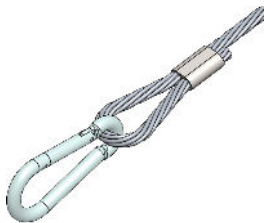

Step 2:

Wrap the *looped cable* around the Unistrut Channel and clip the other loop into the same *carabiner* as Step 1.

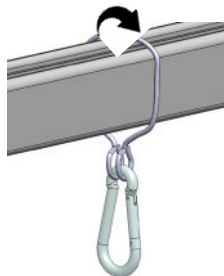

Step 3:

Clip the carabiner to the Standard Mounting Brackets to suspend the brackets. Hook the bracket ends into the hanger holes on the light fixture.

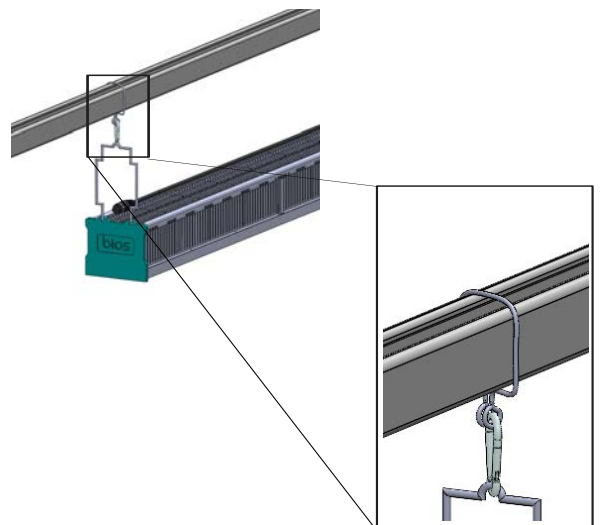

Repeat Steps 1-3 for all fixtures down the length of the Unistrut Channel.

Unistrut Mounting Instructions - Channel-Side Up or Down

The following outlines the steps for mounting the fixtures to a Unistrut Channel, where the channel is mounted with open channel-side facing up OR down.

Recommended Hardware

Note: Hardware not included

Strut Channel Nut with Spring

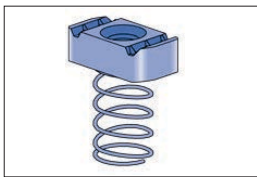

Eye Bolt



Washer



Nut



Small Y-Cable with Carabiners
SKU: BP-000B-000-YKAB02-1

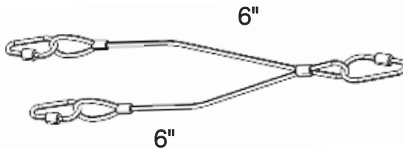

Note: Hardware not included, must be ordered separately

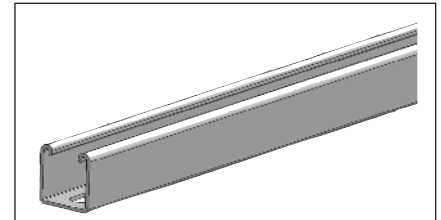

Unistrut Channel-Side Up

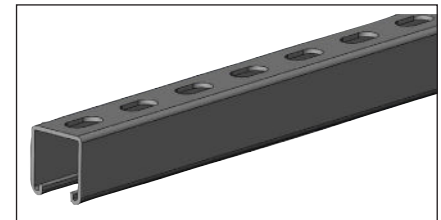

Unistrut Channel-Side Down

Installation Notes

Step 1:

Determine the channel orientation of the unistrut being installed.

Unistrut Channel-Down

Follow assembly instructions outlined on page 4.

Unistrut Channel-Up

Follow assembly instructions outlined on page 7.

Step 2:

Ensure the **eye bolts** are secured and orientated correctly for the appropriate channel direction.

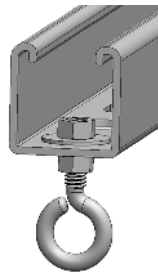

Unistrut Channel-Side Up

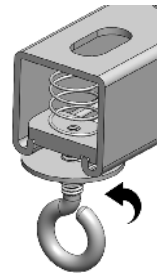

Unistrut Channel-Side Down

Step 3:

Locate the mounting hardware along the channel so the hardware spacing aligns with the width of the power supply being mounted.

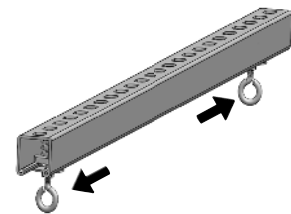

Step 4:

Clip the carabiner on the single end of the looped y-cable to the eye bolts. Clip the other suspended carabiners into the hanger holes on the power supply.

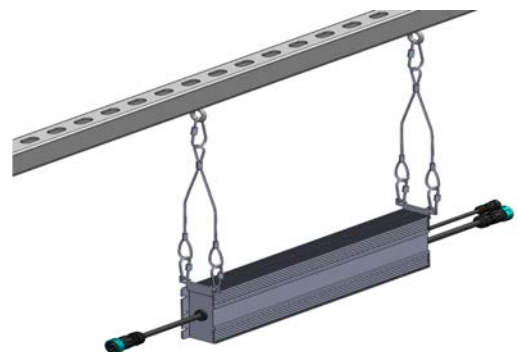

Repeat Steps 1-4 for all power supplies down the length of the Unistrut Channel.

Unistrut Mounting Instructions - Channel-Side Up or Down

The following outlines the steps for mounting the fixtures to a Unistrut Channel, where the channel is mounted with open channel-side facing up OR down.

Recommended Hardware

Note: Hardware not included

Bolt

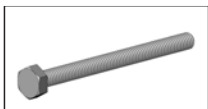

Washer



Nut

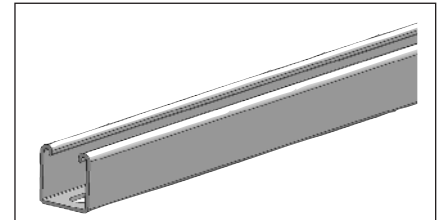

Unistrut Channel-Side Up

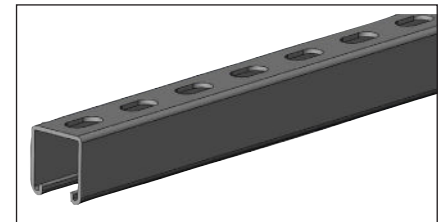

Unistrut Channel-Side Down

Installation Notes

Step 1:

Place PSU on unistrut and align both center mounting holes with unistrut holes.

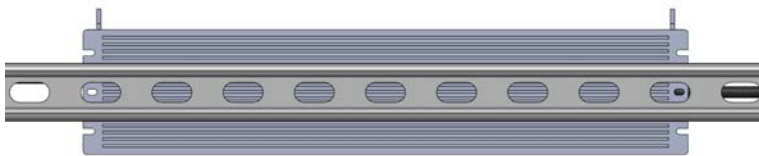
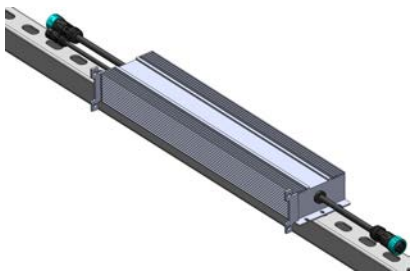

Step 2:

Place a bolt through each set of holes, attach a washer, then tighten with the bolts to secure PSU in place.

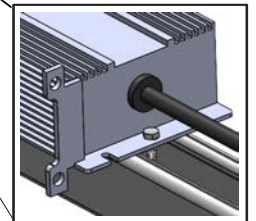
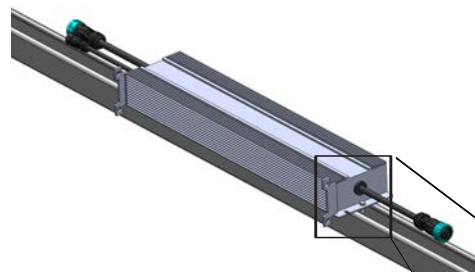

Repeat Steps 1-2 for all power supplies down the length of the Unistrut Channel.

AC & DC Power Cable Connections:

Connect DC cable between the PSU and the Fixture.

- Cable coming out of the power supply can be attached to the cable coming out of the fixture (see page 3 for details.) Please contact help@bioslighting.com if you need assistance.

Connect AC cable between PSU and Power source.

- If using an AC Pig-Tail Cable, double check that the J-Box is de-energized before beginning the work.
 - The circuit should be off before making any electrical connections.

Note: Please use licensed electrical contractor for this work

- If using a NEMA plug cable, be sure the plug is rated to match your circuit.

Double check all cable connection points to be sure of connectivity.

Fixture Testing/Commissioning:

IMPORTANT:

Once the fixtures are securely hung and the power cables are connected, energize the circuit to test the fixture.

The fixtures will illuminate at full brightness. Always be careful with your eyes.

- Burn in the fixtures for 30 minutes to reach thermal equilibrium.
- Note that fixtures are equally bright, no failing diodes, no flickering, and confirm the Thermal Plot for proper light coverage.
- Power off fixtures before making any needed adjustments.

Dimming Option:

It is recommended to make the dimming connection at the power supply after the fixture commissioning is complete. This helps filter potential issues and will make troubleshooting much easier.

- Connect dimming pig-tail cables and optional Dimming Chain Cables (T-Cables & Jumper Cables) per the Dimming Cable Installation Guide on the BIOS Lighting website.
- Once all dimming cables are installed, energize the fixture circuit, and begin the commissioning of the dimming system per the manufactures specifications.